

Santa Claus Carrier Basket Sewing Tutorial 🧑‍🎄🧺

Create an adorable Santa Claus Carrier Basket using this pattern. This project is perfect for Christmas decorations, gift baskets, candy holders, holiday parties, classroom gifts, or festive home décor. The pattern is designed with seam allowances already included, making it beginner-friendly while still producing a professional-looking result.

STEP-BY-STEP QUILTED SANTA BASKET SEWING GUIDE



PATTERN PIECES & CUTTING LIST

- 1 Main Body Piece (A)**
Cut 1 outside
Cut 1 Green
Cut 1 Wadding
- 2 Front Santa Face Piece (B)**
Cut 1 outside
Cut 1 Wadding
- 3 Santa Beard Appliqué (C)**
- 4 Santa Mustache Appliqué (D)**
- E Handle Strip (E)**
2cm x 1cm
- F Binding Strip (F)**
1cm

STEP-BY-STEP INSTRUCTIONS

1 Step 1: Prep & Quilt Sandwich

Backings
Wadding
Top (Right Side Up)

Pin Baste layers

Create Quilt Sandwich: Backing (Wrong Side Up) + Wadding + Top (Right Side Up)

USE: QUILTING METHOD

2 Step 2: Machine Quilting

Machine-Quilt layers.
Example: Diagonal Cross-Hatch (Stitch in the Ditch or Echo Quilting)

3 Step 3: Construct Main Bag

USE: TOPSTITCHING, STITCH-IN-THE-DITCH

4 Step 4: Appliqué Santa Face

Use fusible web. Machine or Hand appliqué beard & mustache (Detail D & C). Sew on eyes & nose.

USE: BLANKET STITCH (Machine or Hand)

Step 5: Assemble Basket Sides & Base

Step 6: Finish Edges & Binding

A: Apply inner binding to raw edges
B: Sew handle strip, attach pom-poms
C: Sew finished handle to main body

USE: BIAS BINDING, LADDER STITCH (for hand-finishing binding)

GLOSSARY OF U.S. SEWING METHODS

QUILT SANDWICH The 3 layers basted together before quilting	APPLIQUÉ Attaching fabric shapes to a base (Machine Blanket Stitch)	STITCH-IN-THE-DITCH Stitching on the seam line of a previous quilt block	ECHO QUILTING Stitches that repeat the line of an appliqué or feature	TOPSTITCHING Decorative or structural stitch close to the edge on the right side	BIAS BINDING Enclosing raw edges with folded strip of fabric (Ladder Stitch shown)
---	---	--	---	--	--

- <https://handcrafted.craftsforlove.com/> SEE THE BEST PATTERNS

The finished basket measures approximately **20 cm (7.9 inches) tall, 25 cm (9.8 inches) wide at the base**, with an **18 cm (7.1 inches) Santa front panel**.

This tutorial follows the pattern exactly and explains every step in detail so anyone can successfully complete the project from start to finish.

Materials You'll Need

Prepare all materials before starting.

Fabrics

- Green fabric (basket body)
- Red fabric with white dots (strap bands)
- Skin-tone fabric (Santa's face)
- White felt or white fabric (beard, mustache, hat, pom-pom)
- Pink fabric (nose)
- Black felt or black embroidery thread (eyes)
- White lining fabric
- Optional coordinating Christmas fabrics

Stabilizers

- Quilt batting or fusible batting
- Lightweight interfacing (optional)

Sewing Supplies

- Sewing machine
- Sharp fabric scissors
- Small embroidery scissors
- Fabric clips or sewing pins
- Fabric marker or chalk
- Iron and ironing board
- Rotary cutter and ruler (optional)
- Hand sewing needle
- Matching sewing thread
- Fabric glue (optional for appliqué)

 **FULL PATTERN BELLOW TO PRINT FOR SEW** 

- <https://handcrafted.craftsforlove.com/> SEE THE BEST PATTERNS

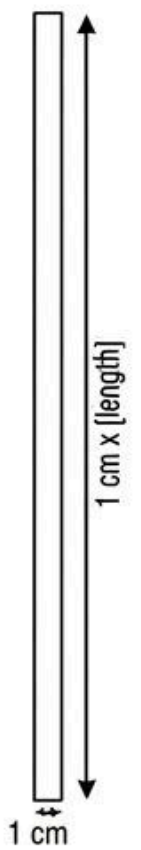
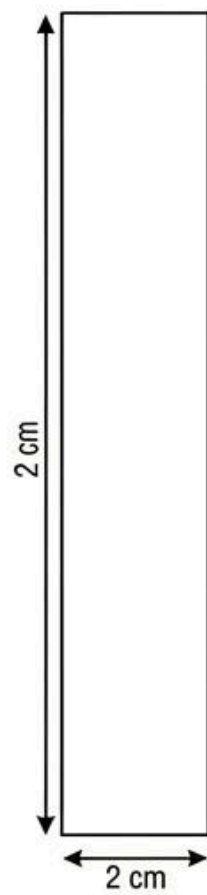
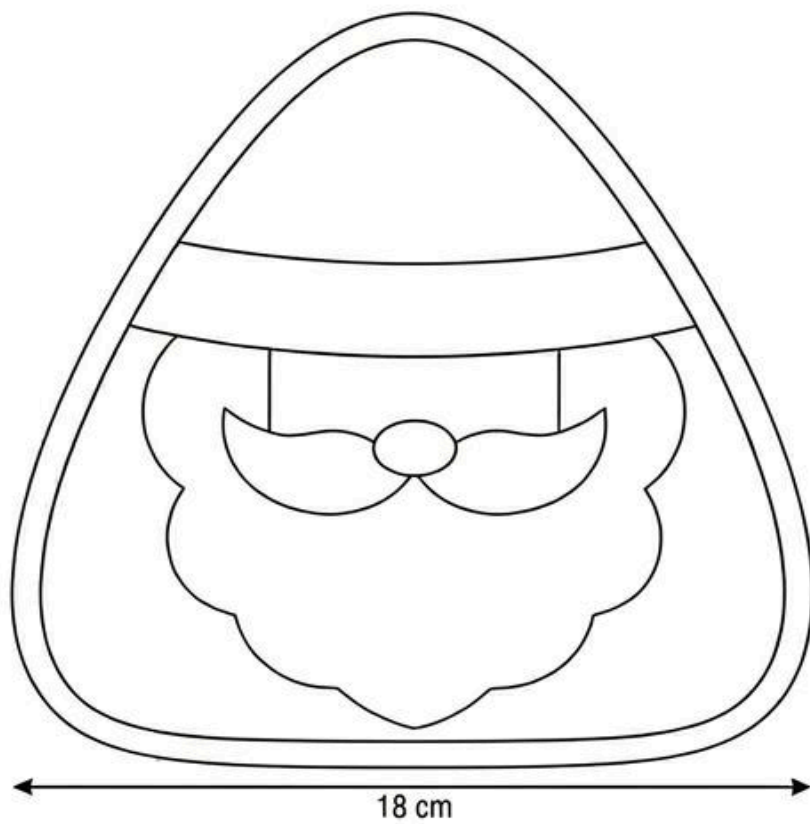

Top Arc (for opening): 35 cm

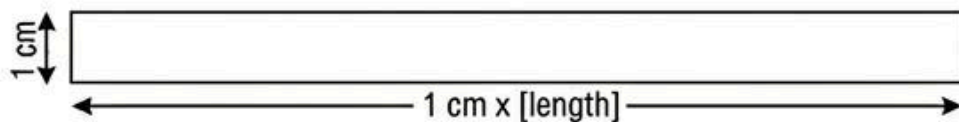
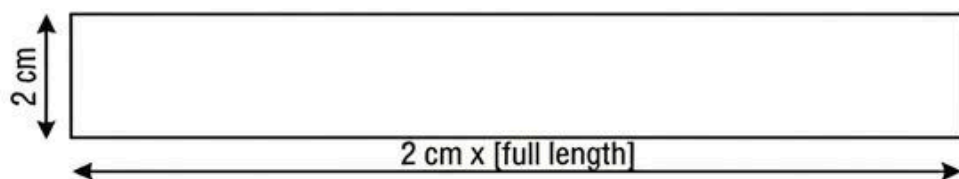
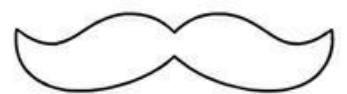
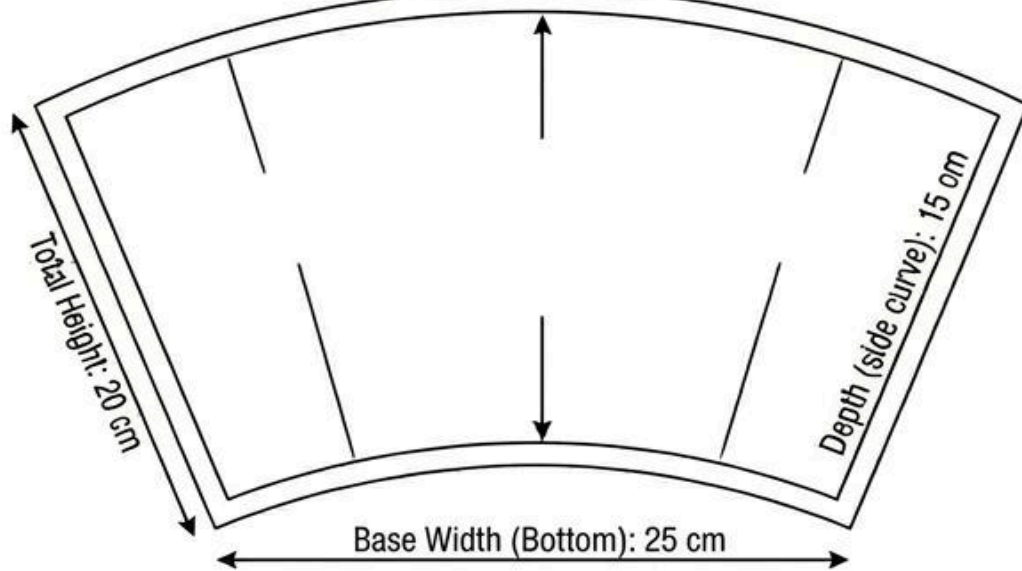

- <https://handcrafted.craftsforlove.com/> SEE THE BEST PATTERNS

Print the Pattern

Print the pattern on **A4 paper at 100% scale**.

Do not select:

- Fit to Page
- Shrink to Fit
- Scale to Printable Area

Verify accuracy by measuring the **1 cm test square** printed on the sheet.

If the square measures exactly 1 cm, your pattern is correctly printed.

Cut out every paper pattern piece.

Pattern Pieces Included

Part A – Side Body and Bottom

Cut:

- 2 Outer (green holly fabric)
- 2 Lining
- 2 Batting

Measurements:

- Total height: 20 cm
- Base width: 25 cm
- Top opening arc: 35 cm
- Side curve depth: 15 cm

Part B – Santa Face Front

Cut:

- 1 Outer
- 1 Lining
- 1 Batting

Finished panel measures approximately:

18 × 18 cm

- <https://handcrafted.craftsforlove.com/> SEE THE BEST PATTERNS

Part C – Beard

Cut:

- 1 white felt or white fabric

This is an appliqué piece.

Part D – Mustache

Cut:

- 1 white felt or white fabric

This is also an appliqué piece.

Part E – Bottom Strap Band

Cut:

- 2 Outer
- 1 Batting

Size:

2 cm × full basket length

Part F – Finishing Bias Band

Cut:

Several strips

Width:

1 cm

Length:

Long enough to finish all exposed seams and edges.

- <https://handcrafted.craftsforlove.com/> SEE THE BEST PATTERNS

Part 3 – Vertical Strap Band

Cut:

- 2 Outer
- 1 Batting

Size:

18 cm × 2 cm

Hat and Pom-Pom

Cut one of each from white felt or white fabric.

Prepare the Basket Body

Place one batting piece behind each outer basket panel.

Quilt them together if desired.

Simple vertical quilting lines work beautifully and help stabilize the basket.

Trim any excess batting.

Prepare the Santa Front Panel

Layer in this order:

- Outer fabric
- Batting
- Lining

Baste around the edges within the seam allowance.

This creates one sturdy Santa front panel.

Create Santa's Face

Using the placement shown on the pattern:

Sew or glue the following pieces:

- Face
- Beard
- Mustache
- Hat
- Hat brim

- <https://handcrafted.craftsforlove.com/> SEE THE BEST PATTERNS

- Pom-pom
- Nose

The beard outline shown on the pattern can be stitched as decorative quilting.

This adds beautiful texture and keeps the beard securely attached.

Add the Eyes 🐾🐾

The eyes may be made using:

- Small black felt circles
- Hand embroidery
- Machine embroidery
- Safety eyes (if decorative only)

Place them evenly above the nose

Stitch the Beard Details

Using white thread, stitch along the decorative beard guide lines.

These stitching lines create depth and make the beard appear fluffy.

Take your time and sew slowly around the curved sections.

Assemble the Basket Body

Place the two quilted outer basket pieces right sides together.

Sew along:

- Both curved side edges
- Bottom curve

Leave the top opening completely open.

Clip the curved seam allowances without cutting through the stitching.

Turn right side out.

Press carefully.

- <https://handcrafted.craftsforlove.com/> SEE THE BEST PATTERNS

Sew the Lining

Repeat the same process using the two lining pieces.

Leave a small turning opening along one bottom section.

Press.

Attach the Santa Panel

Position the completed Santa panel on the front of the basket.

Center it carefully.

Topstitch around the entire outside edge close to the seam.

This secures the decorative front permanently to the basket.

Make the Strap Bands

For each strap:

Layer:

- Outer fabric
- Batting
- Outer fabric

Sew along both long edges.

Turn right side out.

Press flat.

Topstitch both sides.

Create:

- One vertical strap (18 × 2 cm)
- One bottom strap (2 cm × basket width)

- <https://handcrafted.craftsforlove.com/> SEE THE BEST PATTERNS

Attach the Decorative Straps

Place the vertical strap centered on the Santa panel.

Sew along both long edges.

Next, position the horizontal strap near the lower portion of the basket.

Topstitch in place.

These decorative straps give the basket its finished holiday appearance.

Join the Basket and Lining

Place:

Outer basket inside the lining.

Right sides should face each other.

Match:

- Side seams
- Top edges

Pin around the entire opening.

Sew all the way around.

Turn the Basket Right Side Out

Pull the basket through the opening left in the lining.

Push out every curved corner gently.

Hand stitch the lining opening closed using an invisible ladder stitch.

Push the lining inside the basket.

Press the top edge.

Finish the Top Edge

Apply the **Part F finishing band** around the entire basket opening.

Fold neatly over the raw edge.

Topstitch close to both edges for a clean professional finish.

- <https://handcrafted.craftsforlove.com/> SEE THE BEST PATTERNS

Final Press

Lightly steam press the entire basket.

Shape the sides by hand.

If needed, insert a folded towel while pressing so the basket keeps its rounded shape.

Optional Embellishments ✨

You can personalize your Santa basket with:

- Jingle bells
- Small bows
- Embroidery
- Buttons
- Snowflake appliqués
- Holly leaves
- Red berries
- Decorative machine stitches
- Metallic thread accents
- Personalized names

Helpful Sewing Tips 💡

- Read through the entire tutorial before beginning.
- Keep seam allowances consistent throughout the project.
- Clip curved seams to reduce bulk.
- Press after every major sewing step.
- Pin curved edges generously for better accuracy.
- Test decorative stitches on scrap fabric first.
- Use felt for appliqué pieces if you prefer edges that won't fray.
- Take your time aligning the Santa face for the best finished appearance.

Finished Project 🎄

Your completed **Santa Claus Carrier Basket** is a sturdy, festive fabric basket featuring a cheerful Santa face, quilted construction, decorative strap bands, and a fully lined interior. It is perfect for holding Christmas treats, holiday gifts, party favors, small toys, ornaments, or seasonal decorations. With careful cutting, accurate stitching, and regular pressing throughout the process, this pattern creates a polished, professional-quality basket that can be enjoyed year after year or gifted as a handmade holiday keepsake.